

# CUT | S190-191

Francesco Rota | 2013



# CUT

Francesco Rota | 2013

Two elements are enough, at opposite ends, in plastic and fabric. Just bring them together, give the former an external shape and the latter a soft interior. Or you can change everything and leave the colour and tactile pleasure of the fabric weave to embrace every part. Just choose from the countless combinations available, and you have CUT, the armchair with a versatile character. There is no room for inflexibility.



# CUT

Francesco Rota | 2013

## | S190-191 star-shaped swivel base

Chair with Baydur® fire resistant polyurethane shell, white or black, front or fully upholstered with fire resistant foam and covered with fabric, ecoleather or leather. Swivel star base in sandblasted aluminium or powder coated. Glides in polythene.

TEST 1 IM - Steelcut

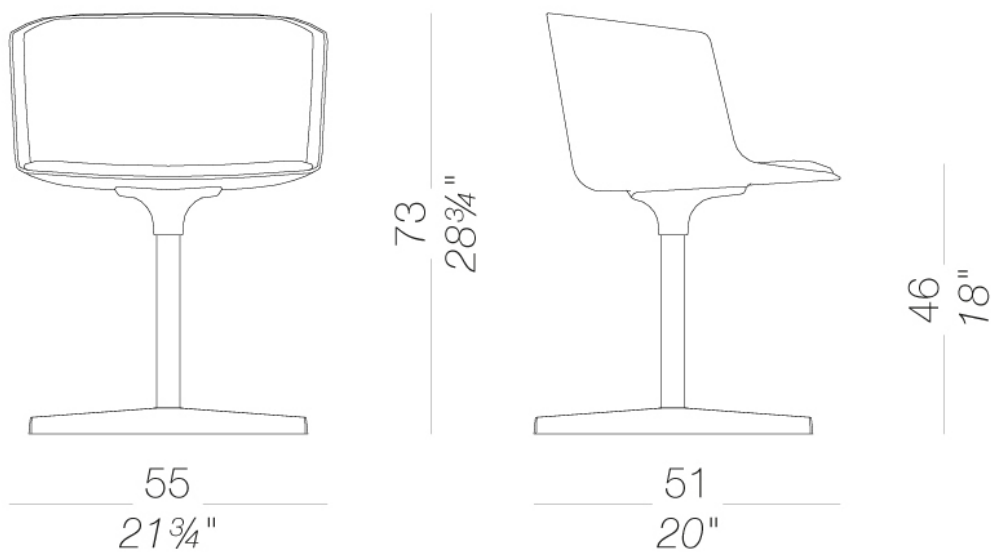

# CUT | S190-191

Francesco Rota | 2013

## frame



powder coating  
black  
1 Colors

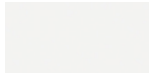

powder coating  
white  
1 Colors



metal  
aluminium  
1 Colors

## shell



plastics  
Baydur®  
2 Colors

## upholstery

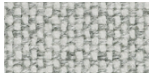

fabric  
Hallingdal 65  
47 Colors



fabric  
Canvas 2  
40 Colors



fabric  
Steelcut Trio 3  
48 Colors

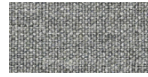

fabric  
Remix 3  
24 Colors

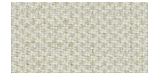

fabric  
Clara 2  
24 Colors



fabric  
Fiord 2  
24 Colors



fabric  
Divina MD  
24 Colors



fabric  
Divina Melange 3  
38 Colors



fabric  
Tonica 2  
39 Colors



fabric  
Medley  
37 Colors

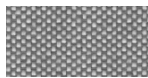

fabric  
Maya  
43 Colors



fabric  
Jet  
44 Colors

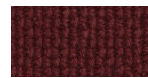

fabric  
Lapalma Smart  
18 Colors

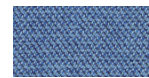

fabric  
Capture  
43 Colors



fabric  
Crisp  
40 Colors

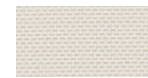

fabric  
Nattè  
23 Colors



fabric  
Iris  
24 Colors



fabric  
Steelcut 2  
37 Colors



soft-leather  
soft-leather  
7 Colors



ecoleather  
GRIMM FR  
24 Colors



ecoleather  
Valencia c5  
59 Colors

**consult the portfolio for the range of colors, fabrics, eco-leather, soft-leather.**

## use and maintenance instructions

Clean all parts in wood, leather, fabric and metal with a damp cloth or a diluted neutral cleaner. Do not use cleaners with alcohol, bleach, solvent or abrasive products. Any liquid spilt on the product must be wiped up immediately. When lifting or moving the product, hold it on the structure and not under the seat. The product should not be subjected to unbalanced weights, as it is designed for a proper rest on the foothold (on four legs or on the base). Our company relieves from any responsibility in case of damage caused to fragile floors. Avoid any improper use of the product: do not step on the product, on the footrest or on the armrests. Avoid any movements that could compromise the proper functionality of the product or the safety of the users. Wood and leather, being natural materials, could be easily damaged. Small impurities or imperfections are within quality standard range. Do not expose the product to weather conditions or atmospheric agents, nor to heat sources over 40°C. Also products for outdoor use could be afflicted by atmospheric agents. The product could undergo possible exterior changes due to particular exposure to heat, humidity and saltiness. An appropriate and frequent maintenance and cleaning of the product enhances its durability. The product could change colour and shade, if exposed to direct sunlight. Maintenance has to be carried out by experienced staff. Dispose of the package only after assembling the product, in order to avoid the loss of ironmongery and components. Once the product has been dismantled, the product itself or its components must be given to the public garbage disposal system, according to the legislation in force.